



Product designation				Modular switching power supplies
Product type designation				PSL1M
Input characteristics				
Input type				Single-phase
Rated supply voltage AC			VAC	Multivoltage 100...240
Operating range	AC			
		min	VAC	90
		Max	VAC	264
	DC			
		min	VDC	120
		Max	VDC	375
Rated frequency			Hz	50/60
Operational frequency		min	Hz	47
		max	Hz	63
Current consumption Max			mA	1500
PFC				No
Insulation voltage Input/Output		AC	VAC	3000
		DC	VAC	4242
Internal fuse (250VAC)				T2A 250VAC
Output characteristics				
Rated output voltage DC			VDC	12
Voltage trimming (potentiometer) DC		min	VDC	12
		Max	VDC	14
Rated output current			A	4.5
Rated output power			W	54
Temperature coefficient			%/°C	±0.03
Line adjustment			%	±1
Load adjustment			%	±1
Efficiency			%	84
Overload protection				110...150%
Short-circuit protection				Fold forward
Ripple & noise			mV	50
Parallel connection			Nr.	No
Indications				
LED indicator for power on				Yes
LED indicator for low voltage				Yes
Connections				
Terminals type				Screw
Ambient conditions				

Temperature

Operating temperature

min	°C	-40
max	°C	+71

Storage temperature

min	°C	-40
max	°C	+85

Derating

%/°C	2.5%/°C above 56°C
------	--------------------

Housing

Execution (n° of modules)

4

Material

Plastic

IEC degree of protection

IP20

Dimensions (W x H x D)

mm 71 x 96 x 56.2

Weight

g 311

Installations

Mounting

On 35mm DIN rail

Dimensions

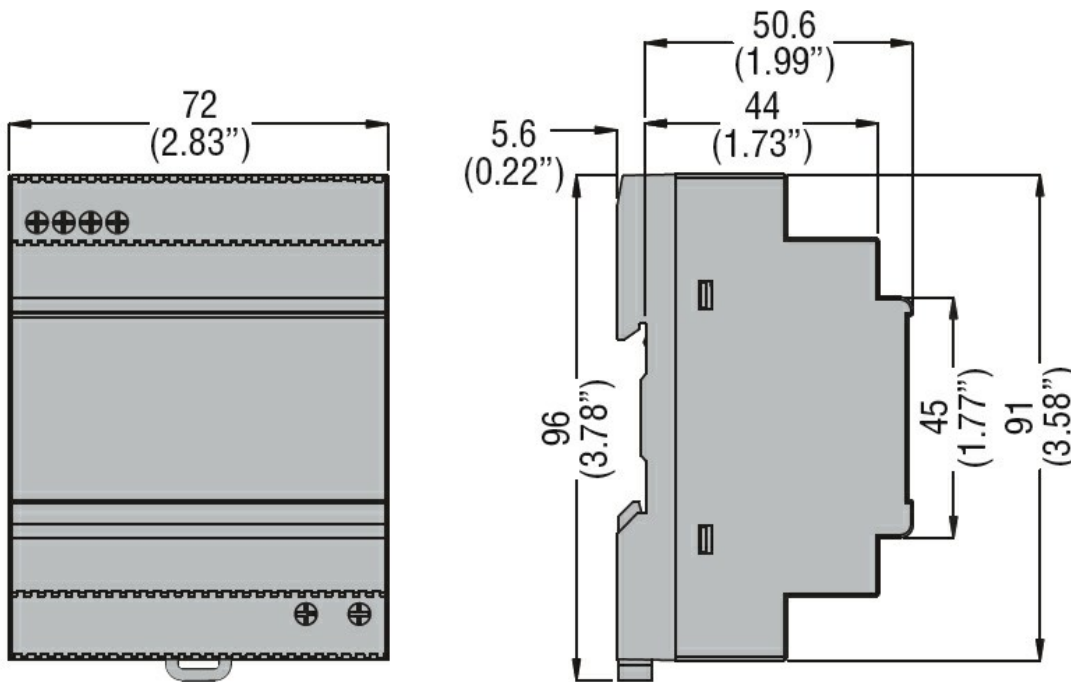

Wiring diagrams

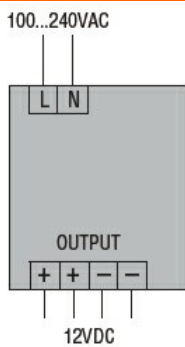

Certifications and compliance

Compliance

CSA C22.2 n°14

IEC/EN/BS 61000-6-2

IEC/EN/BS 61000-6-3

IEC/EN/BS 62368-1

UL 508

Certificates

cULus

EAC

RCM

ETIM classification

ETIM 8.0

EC002540 - DC-
power supply