



Floodlight EcoMax G3

- Equipped with breather to prevent condensation



Specifications

Item Code	Item Description	Equivalent to (W)	Power (W)	Lumen	Efficacy (lm/W)	CCT (K)	With sensor	Degree of protection (IP)	Surge protection	Weight (kg/pc)
On-Off										
709000073100	LEDflood-E3 Re246-70W-830-BL	HID 150W	70	8400	120	3000	No	IP66	4 kV	2.04

Accessories



543098021900
LEDFixture-IP68-Connector-Kit-3



599000004600
LEDStreet-SE-ExtensionCable-6m

Packaging Information

Item		Box				
Item Code	Item Description	EU HS Code	Dimensions (mm) (LxWxH)	Gross Weight (kg)	EAN	pc/box
709000073100	LEDflood-E3 Re246-70W-830-BL	94054239	301x45x312	2.11	6941497776518	1
543098021900	LEDFixture-IP68-Connector-Kit-3	39174000	265x245x205	0.08	6941497708991	1
599000004600	LEDStreet-SE-ExtensionCable-6m	85444290	100x60x350	0.68	6956321815370	1

5 YEARS WARRANTY



Technical Specifications	
Lifetime (L70)	50,000 h
Lifetime (L80)	30,000 h
On-/Off-cycles	100,000
Colour consistency (SDCM)	4
Dimmability	On-Off
Sensor type	No sensor
Sensor technology	No sensor
Beam angle	100°
Finishing	Black
Colour rendering index (CRI)	> 80
Impact strength	IK07
Protection class	I
Risk group (EN 62471)	RG1
With control gear	Yes
Glow wire test	850°C
Power factor	≥ 0.9

Electrical Supply	
Frequency	50/60 Hz
Nominal voltage	220-240 V
DC input voltage	No
230V Cable length	1 m

Mechanical Properties	
Housing material	Die-casted Aluminum
Optical material	Polycarbonate
Cover material	Tempered glass
Coastal proof	Yes

Ambient Conditions	
Operating temperature	-30-+50°C
Operating temperature MD	n/a
Application temperature	+25°C
Storage environment	-40-+60°C

Dimensional Drawing (mm)

LEDflood-E3 Re246
70W & 100W

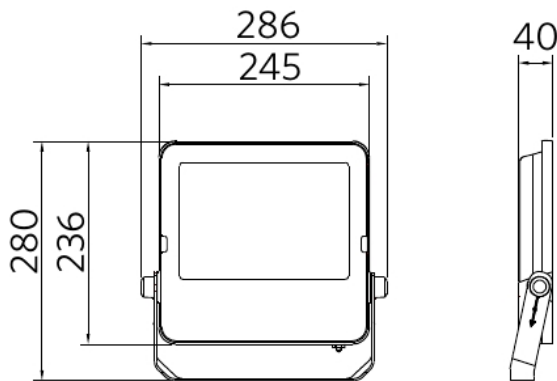

Photometric Data

